

NOTES

1. WHEN THIS DRAWING IS USED AS AN ORDER SUBMITTAL, IT MUST BE SIGNED, AND AN ORDER SUBMITTAL FORM MUST BE INCLUDED.
2. 30 YEAR WARRANTY COVERAGE - SEE INTERCEPTOR LIMITED WARRANTY FOR DETAILS
3. OPTIONAL ACCESSORIES (LEVEL ALARMS, EXTENSION RISERS, STREET BOXES) ARE ALSO AVAILABLE.
4. ALL UPC LABELED GREASE INTERCEPTORS MUST SHIP FROM THE ANAHEIM FACILITY.

DESIGN PARAMETERS

1. TANK SIZE: 4' DIA SINGLE-WALL, 48 1/2" O.D.
2. NOMINAL TANK CAPACITY: 1,800 GALLONS.
3. NOMINAL TANK WEIGHT: 1,700 LBS.
4. INVERT DIMENSION FROM TANK I.D.
5. CAPACITY AT FLOW LINE: 1500 GALLONS.
6. MAX GREASE CAPACITY: 883 GALLONS.
7. MAX SOLIDS CAPACITY: 463 GALLONS.

APPROVAL

THE UNDERSIGNED ACKNOWLEDGES AND AGREES TO THE USE AND DESIGN PARAMETERS AS DETAILED ON THIS DRAWING AND IN THE ACCOMPANYING ORDER SUBMITTAL FORM AND HEREBY APPROVES FABRICATION.

SIGNATURE _____

PRINTED NAME _____ DATE _____

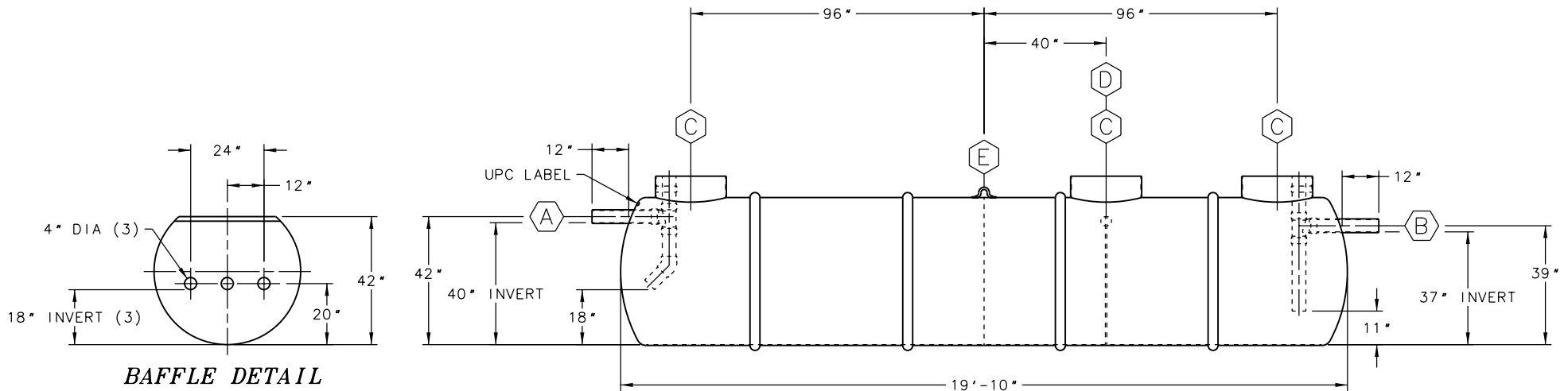
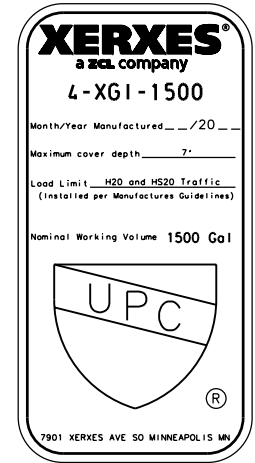

ITEM	QTY	DESCRIPTION
(A)	1	4"DIA SCH 40 PVC INLET PIPE WITH INTERNAL SANITARY TEE, PIPES & 45° ELBOW
(B)	1	4"DIA SCH 40 PVC OUTLET PIPE WITH INTERNAL SANITARY TEE & PIPES
(C)	3	RISER PIPE, 23 3/8" O.D., FOR 24"(NOMINAL) ACCESS OPENING
(D)	1	42" HIGH PLATE BAFFLE WITH 3-4"DIA HOLES (18" INVERT)
(E)	1	LIFTING LUG

ZCL | XERXES®

TITLE
**MODEL GI-4-1500-UPC
 GREASE INTERCEPTOR**

DATE 1-17 DR. NO. S11-914.00

INDUSTRY TYPE: M210 PLUMBING ENGINEERED SOLUTIONS